

TAG: _____

Submittal

Wall-Mount Air Handlers 2 – 3 Ton Cooling/Heat Pump

JMM5A0A24M21SA
JMM5A0B30M21SA
JMM5A0B36M31SA

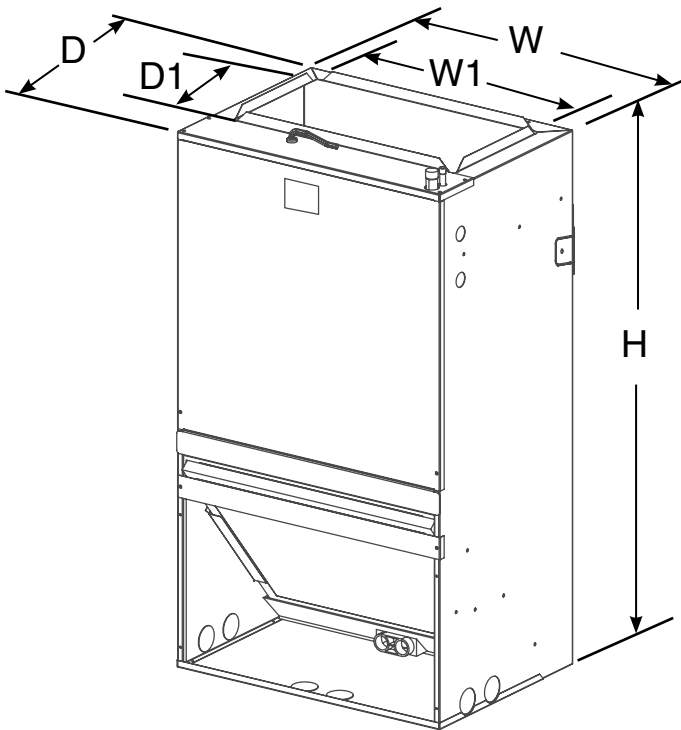

Dimensional and Clearance Data

MINIMUM UNIT CLEARANCE TABLE		
	TO COMBUSTIBLE MATERIAL (REQUIRED)	SERVICE CLEARANCE (RECOMMENDED)
SIDES	0"	0"
FRONT	0"	24"
BACK	0"	0"
INLET DUCT	0"	0"
OUTLET DUCT	0**	

* 0 " FOR THE FIRST 3 FT. OF OUTLET DUCT WHEN ELECTRIC HEATERS ARE INSTALLED

	PRODUCT DIMENSIONS inch (mm)						Flow Control	Gas Line Braze	Unit weight/ Shipping Weight [LBS(kg)]
	Height H	Width W	Width W1	Depth D	Depth D1				
JMM5A0A24M21SA	36-1/2" (928)	20-1/2" (522)	17-2/5" (442)	15" (381)	9-1/2" (242)	TXV	3/4"	79/93 (36/42)	
JMM5A0B30M21SA	39-1/2" (1004)	22" (559)	18-3/4" (477)	19" (483)	9-1/2" (242)	TXV	3/4"	97/115 (44/52)	
JMM5A0B36M31SA	39-1/2" (1004)	22" (559)	18-3/4" (477)	19" (483)	9-1/2" (242)	TXV	3/4"	97/115 (44/52)	

PRODUCT SPECIFICATIONS

MODEL	JMM5A0A24M21SAA	JMM5A0B30M21SAA	JMM5A0B36M31SAA
RATED VOLTS/PH/HZ.	208-230/1/60	208-230/1/60	208-230/1/60
RATINGS	See O.D. Specifications	See O.D. Specifications	See O.D. Specifications
INDOOR COIL — Type	Plate Fin	Plate Fin	Plate Fin
Rows — F.P.I.	5 - 11	5- 14	5- 14
Face Area (sq. ft.)	2.20	3.00	3.00
Tube Size (in.)	9/32	9/32	9/32
Refrigerant Control	TXV	TXV	TXV
Drain Conn Size (in.)	3/4 NPT	3/4 NPT	3/4 NPT
DUCT CONNECTIONS	See Outline Drawing	See Outline Drawing	See Outline Drawing
INDOOR FAN — Type	Centrifugal	Centrifugal	Centrifugal
Diameter-Width (In.)	10-5/6 X 6-1/7	10-3/5 X 9-10/7	10-3/5 X 9-10/7
No. Used	1	1	1
Drive - No Speeds	Direct - 5	Direct - 5	Direct - 5
CFM vs. in. w.g.	See Fan Performance Table	See Fan Performance Table	See Fan Performance Table
No. Motors — H.P.	1 - 1/3	1 - 1/2	1 - 1/2
Motor Speed R.P.M.	1050	1050	1050
Volts/Ph/Hz	208-230/1/60	208-230/1/60	208-230/1/60
F.L. Amps	1.9	2.7	2.7
FILTER			
Filter Furnished?	No	No	No
Type Recommended	Throwaway	Throwaway	Throwaway
No.-Size-Thickness	1 - 16X 20 - 1 in.	1 - 20X 20 - 1 in.	1 - 20X 20 - 1 in.
REFRIGERANT	R-410A	R-410A	R-410A
Ref Line Connections	Brazed	Brazed	Brazed
Coupling or Conn. Size — in. Gas	3/4	3/4	3/4
Coupling or Conn. Size — in. Liq.	3/8	3/8	3/8
DIMENSIONS	H x W x D	H x W x D	H x W x D
Crated (In.)	39-3/8x22-6/7x17-1/3	42-4/7x24-1/4x21-2/7	42-4/7x24-1/4x21-2/7
Uncrated	36-1/2x20-1/2x15	39-1/2x22x19	39-1/2x22x19
WEIGHT			
Shipping (Lbs.)/ Net (Lbs.)	93/79	97/115	97/115

Performance and Electrical Data – JMM5A0A24–B36

AIR FLOW PERFORMANCE (Standard CFM)

MODEL SIZE	BLOWER SPEEDS	EXTERNAL STATIC PRESSURE (INWC.)								
		0	0.1	0.2	0.3	0.4	0.5	0.6	0.7	0.8
JMM5A0A24M21SA	TAP 5	913	881	848	818	792	763	731	691	650
	TAP 4 - Factory	825	787	753	717	682	650	617	580	540
	TAP 3	737	700	663	630	589	550	511	474	436
	* TAP 2	675	632	596	555	521	480	440	399	366
	TAP 1	590	548	499	455	430	368	338	309	263
JMM5A0B30M21SA	TAP 5	1362	1325	1266	1238	1197	1159	1119	1080	1040
	TAP 4	1282	1242	1176	1151	1111	1071	1028	975	936
	TAP 3	1267	1225	1143	1120	1078	1036	993	942	897
	TAP 2 - Factory	1157	1111	1052	1016	971	929	884	842	802
	TAP 1	1077	1028	965	932	886	850	804	768	732
JMM5A0B36M31SA	TAP 5	1362	1325	1266	1238	1197	1159	1119	1080	1040
	TAP 4 - Factory	1282	1242	1176	1151	1111	1071	1028	975	936
	TAP 3	1267	1225	1143	1120	1078	1036	993	942	897
	TAP 2	1157	1111	1052	1016	971	929	884	842	802
	TAP 1	1077	1028	965	932	886	850	804	768	732

Shaded boxes represent airflow outside the required 300-400 cfm/ton.

* When JMM5A0B24MM21SA uses the 18 KBTU outdoor unit, select SCFM between 450 and 675.

NOTES:

1. Airflow based upon dry coil at 230V with no electric heat, no filter. For 24, 30, and 36 sizes, airflow at 208V is approximately the same as 230V because the mult-tap ECM motor is a constant torque motor. The torque doesn't drop off at the speeds in which the motor operates.
2. Airflow is equivalent for front or bottom return configurations.
3. SCFM is nearly the same with cooling performance airflow, the gap is in the 1 to 2%.

ELECTRICAL DATA											
JMM5A0A24M21SA											
Heater Model No	No. of Circuits/ Phases	240 Volt					208 Volt				
		Capacity		Heater Amps per Circuit	Minimum Circuit Ampacity	Maximum Overload Protection	Capacity		Heater Amps per Circuit	Minimum Circuit Ampacity	Maximum Overload Protection
		kW	BTUH				kW	BTUH			
No Heater					2.4	15				2.4	15
BAYHTRJ505BRKA*	1/1	5	17100	20.8	28.5	30	3.8	12800	18.0	25.0	30
BAYHTRJ508BRKA*	1/1	7.5	25600	31.2	41.5	45	5.6	19200	27.1	36.3	40
BAYHTRJ510BRKA*	1/1	10	34100	41.7	54.5	60	7.5	25600	36.1	47.6	50

ELECTRICAL DATA											
JMM5A0B30M21SA											
Heater Model No	No. of Circuits/ Phases	240 Volt					208 Volt				
		Capacity		Heater Amps per Circuit	Minimum Circuit Ampacity	Maximum Overload Protection	Capacity		Heater Amps per Circuit	Minimum Circuit Ampacity	Maximum Overload Protection
		kW	BTUH				kW	BTUH			
No Heater					3.4	15				3.4	15
BAYHTRJ505BRKA*	1/1	5	17100	20.8	29.5	30	3.8	12800	18.0	26.0	30
BAYHTRJ508BRKA*	1/1	7.5	25600	31.2	42.5	45	5.6	19200	27.1	37.3	40
BAYHTRJ510BRKA*	1/1	10	34100	41.7	55.5	60	7.5	25600	36.1	48.6	50

ELECTRICAL DATA											
JMM5A0B36M31SA											
Heater Model No	No. of Circuits/ Phases	240 Volt					208 Volt				
		Capacity		Heater Amps per Circuit	Minimum Circuit Ampacity	Maximum Overload Protection	Capacity		Heater Amps per Circuit	Minimum Circuit Ampacity	Maximum Overload Protection
		kW	BTUH				kW	BTUH			
No Heater					3.4	15				3.4	15
BAYHTRJ505BRKA*	1/1	5	17100	20.8	29.5	30	3.8	12800	18.0	26.0	30
BAYHTRJ508BRKA*	1/1	7.5	25600	31.2	42.5	45	5.6	19200	27.1	37.3	40
BAYHTRJ510BRKA*	1/1	10	34100	41.7	55.5	60	7.5	25600	36.1	48.6	50

Mechanical Specifications

STANDARD FEATURES

- Front or bottom return air
- Painted finish on galvanized steel
- Sturdy polycarbonate drain pans
 - The JMM5 wall mount air handler has factory installed drain pans and is shipped for upflow applications only.
- 208/230 - VAC operation
- Multi-speed direct drive blower
 - Constant torque ECM motor with fan-off time delay programming
- Factory installed R-410A thermal expansion valve
- Stud or wall mounting tabs
- Fully insulated cabinet
- 3/4" NPT primary and secondary drains
- **All - aluminum tubes & fins**

OPTIONAL ACCESSORIES

- 5, 7.5, and 10 kW single phase electric heaters
 - Circuit breakers are standard on all single phase 5, 7.5, and 10 kW heaters.
- R-410 TXV kit - 4AYTXVH3G2436
- R-22 TXV conversion kit - 2AYTXVH3G2436
- Front louver panel 20.5" width - BAYFRTLLOUPNL20 (1-Pack)
- Front louver panel 22" width - BAYFRTLLOUPNL22 (1-Pack)
- Return air / service wall panel - BAYTMMWALLPNL1 (20-Pack)
- Return air / service wall panel - BAYTMMWALLPNLS (1-Pack)

